

**Product Name:** London 15 Recessed  
**Product Code:** MTS-10130 L15  
**Model No:** 12100115

### Product Specification / Ürün Özellikleri

London 15 Recessed

**Installation Type :** Recessed

**Body and Heatsink :** Aluminium Injection Body and Heatsink

**Body Color :** Electrostatic Powder Coating

**Led Brand :** Samsung Power Led

**Driver Brands :** Tridonic

**Beam Options :** 15° / 40°

**Protection Type :** IP20 / IP23 (Visible Surface After Installation)

**UGR :** <10

**Hole Size :** ∅36x405

**Dimming Options :** Phase-Cut / 1-10 V / DALI

**Product Dimensions :** H:50mm W:45mm L:412mm

London 15 Sıva Altı

**Montaj Tipi :** Sıva Altı

**Gövde ve Soğutucu :** Alüminyum Enjeksiyon Gövde ve Soğutucu

**Gövde Rengi :** Elektrostatik Toz Boya

**Led Markası :** Samsung Power Led

**Sürücü Markaları :** Tridonic

**Açı Seçenekleri :** 15° / 40°

**Koruma Sınıfı :** IP20 / IP23 (Kurulumdan Sonra Görünür Yüzey)

**UGR :** <10

**Delik Çapı :** ∅36x405

**Dim Opsiyonları :** Triak / 1-10 V / DALI

**Ürün Ölçüleri :** Y:50mm G:45mm U:412mm

	2700K Lumen	3000K Lumen	4000K Lumen	Watt	CRI
Samsung Power Led	3675 lm	3900 lm	4275 lm	37,5 Watt	>80

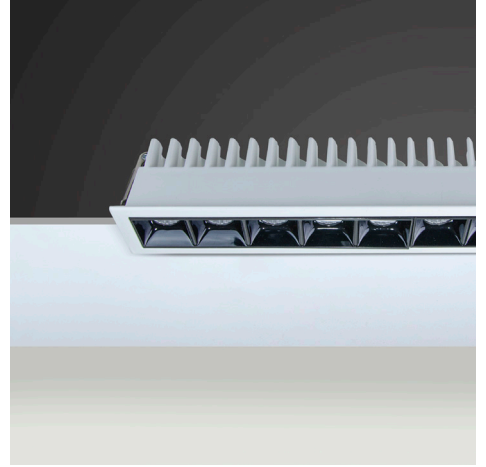
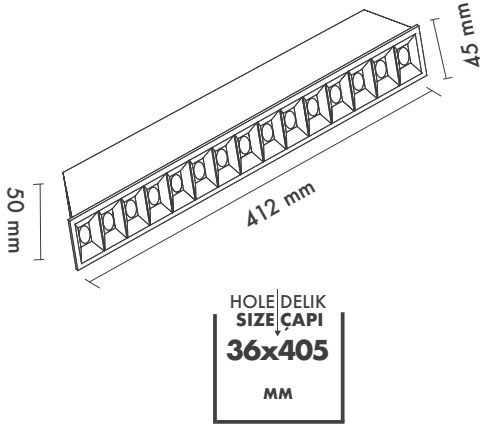
**Technical Informations / Tekniksel Bilgiler**

High-definition optics made of high quality pmma material, integrated in the mirror antiglare screen that defines emission with luminance control UGR<13.



Available Finishes  
Uygulama Renkleri

● Textured White Ral 9016

● Textured Black Ral 9005

● Textured Grey Ral 9006



\*Please check datasheet for more finishes.

\*Daha fazla renk için lütfen datasheeti inceleyiniz.

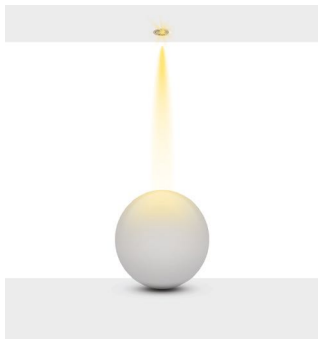
**Beam Informations/ Açısal Bilgiler**

Narrow 15°

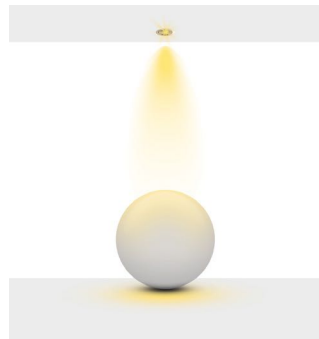

Medium 40°

**Additional / Ek Bilgiler**

**Product Name :**  
1-3 Hours Emergency Battery  
(Tridonic / Local Brands)



**Product Name :**  
Urth Cable + 3 Pin Connector  
with Urth Protection



## Finishes / Painting colors

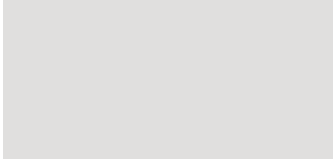

Ral 9208 White  
Beyaz Metsan 01



Ral 9005 Jet Black  
Siyah Metsan 02



Ral 9006 White Aluminium  
Gri Metsan 03



Ral 2121 Orange  
Turuncu Metsan 04



Ral 4005 Purple  
Mor Metsan 09



Ral 4010 Pink  
Pembe Metsan 10



Ral 6018 Grass Green  
Çim Yeşili Metsan 11



Ral 5015 Blue  
Mavi Metsan 25



Ral 3020 Red  
Kırmızı Metsan 26



Ral 6034 Turquoise  
Turkuaz Metsan 29

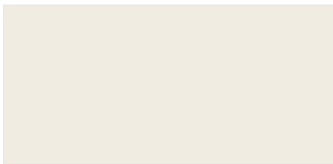

Ral 9010 Creamy White  
Krem Metsan 30

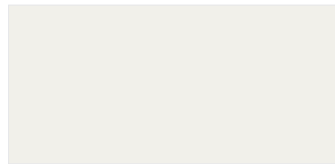

Ral 9016 Rought White  
Dokulu Beyaz Metsan 31

## Finishes / Painting colors

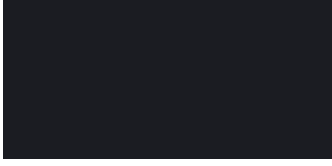

Ral Black  
9365 Siyah

Metsan  
33



Ral Silverly Black  
9006 Simli Siyah

Metsan  
34



Ral Chrome Satin 2  
1290 Krom Saten 2

Metsan  
35



Ral Orange 2  
2004 Turuncu 2

Metsan  
36



Ral Yellow  
1018 Sarı

Metsan  
37



Ral Dark Blue  
5010 Gece Mavisi

Metsan  
38



Ral Brown  
8024 Kahverengi

Metsan  
40



Ral Rough Antrasit  
7022 Dokulu Antrasit

Metsan  
41



Ral Rough Black  
9005 Dokulu Siyah

Metsan  
42



Ral Beige  
1013 Bej

Metsan  
43



Ral Light Gray  
7044 Açık Gri

Metsan  
44



Ral Light Brown  
1019 Sütü Kahve

Metsan  
47

# Finishes / Painting colors



Ral Dark Yellow  
1033 Koyu Sari

Metsan  
48



Ral Night Gray  
7016 Gece Grisi

Metsan  
50



Ral Cooper  
Sc 520 Bakir

Metsan  
51